

## Dräger Polytron 3500

Instructions for Use



# Contents

<b>For Your Safety</b> .....	3
<b>Intended Use</b> .....	4
<b>Installing the Dräger Polytron 3500</b> .....	5
Preparing for installation .....	5
Installing the Pyrolyzer docking station .....	6
Electrical connections .....	6
3-wire connection .....	6
– Installing the 4 to 20 mA current loop .....	6
– Connecting to the central unit with a central power supply: .....	7
Maximum line lengths .....	7
– Connecting to the central unit with individual power supplies: .....	8
Installing the Dräger Polytron 3500 .....	9
Defining the calibration setting .....	9
<b>Starting up the Polytron 3500</b> .....	10
Analogue signal .....	10
Display .....	11
Displays of control LEDs .....	11
<b>Maintenance</b> .....	12
Maintenance intervals .....	12
Calibrating the unit .....	13
Calibrating the zero point .....	14
Calibrating the sensitivity .....	15
Replacing the sensor .....	16
Replacing the pump .....	18
Replace the pump for the measurement branch .....	18
Replace the pump for the principal branch .....	18
Replacing the pyrolysis oven .....	19
Replacing the internal dust filter .....	20
<b>Fault – Cause – Remedy</b> .....	21
<b>Technical Data</b> .....	22
<b>Order List</b> .....	23
Calibration accessories .....	23
Spare parts .....	23
<b>Index</b> .....	24
<b>Drilling templates</b> .....	27
Pyrolyzer Docking Station .....	27

## For Your Safety

### **Strictly follow the Instructions for Use**

Any use of the Polytron 3500 requires full understanding and strict observation of these Instructions for Use. The Polytron 3500 is only to be used for the purpose specified here.

### **Maintenance**

The Polytron 3500 must be inspected and serviced regularly by suitably qualified persons. Repair and general overhaul of the Polytron 3500 may only be carried out by trained service personnel.

We recommend that a service contract be obtained with Dräger Safety and that all repairs also be carried out by them.

Only authentic Dräger spare parts may be used for maintenance.

Observe chapter "Maintenance intervals".

### **Do not operate in explosion-hazard areas**

The Polytron 3500 is not suitable for use in explosion-hazard areas.

### **Accessories**

Do not use accessory parts other than those listed in the order list.

### **Liability for proper function or damage**

The liability for the proper function of the Polytron 3500 is irrevocably transferred to the owner or operator to the extent that the Polytron 3500 was serviced or repaired by personnel not employed or authorised by Dräger Safety or when the Polytron 3500 was used in a manner not conforming to its intended use.

Dräger Safety cannot be held responsible for damage caused by non-compliance with the recommendations given above. The warranty and liability provisions of the terms of sale and delivery of Dräger Safety are likewise not modified by the recommendations given above.

Dräger Safety AG & Co. KGaA

## Intended Use

### Dräger Polytron® 3500

- For stationary, continuous monitoring of gas concentrations in the intake ambient air, with built-in DrägerSensor®.
- Polytron 3500 is available in three types:

Type	Order No.	
	Polytron 3500	DrägerSensor
Dräger Polytron 3500 0 to 50 ppm NF <sub>3</sub> (CAS 7783-54-2)	83 18 824	68 11 125
Dräger Polytron 3500 0 to 30 ppm C <sub>5</sub> F <sub>8</sub> (CAS 559-40-0)	83 18 825	68 11 120
Dräger Polytron 3500 0 to 30 ppm C <sub>4</sub> F <sub>6</sub> (CAS 685-63-2)	83 18 826	68 11 120

**Note:**

**Polytron 3500 and DrägerSensors are not commutable. The corresponding DrägerSensor must be used to ensure that the unit functions correctly.**

**ATTENTION! Explosion hazard!**

**Do not operate underground or in explosion-hazard areas!**

**The Polytron 3500 does not meet the standards for flameproofing and explosion protection.**

**Not to be used for intake from explosion-hazard areas!**

**The concentration of flammable substances in the intake air must be limited to values below the LEL (Lower Explosive Limit)!**

**The gas mixture may otherwise be ignited because of the high pyrolysis temperature in the Polytron 3500.**

**Only suitable for use in buildings!**

- Polytron 3500 is designed for connection to the central units Dräger Polytron, Regard, QuadGard, Unigard or to a Programmable Logic Controller (PLC) in order to warn against gas concentrations that can pose a risk to human health.

Polytron 3500 may also be connected to other central units if the following conditions are met:

- Industrial standard 4 to 20 mA input signal
- Operating voltage on the Polytron 3500 = 24 V DC ±2 V.

On delivery, the Polytron 3500 is configured for the measuring range and gas to be measured. This information can be found on a label below the service port. The Order No. of the sensor to be used is also specified there.

- The display on the Polytron 3500 indicates the actual gas concentration and makes calibration easier.  
False alarms during calibration are avoided by a special maintenance mode with output of a maintenance signal.



® Polytron is a registered trademark of Dräger.  
DrägerSensor is a registered trademark of Dräger.

## Installing the Dräger Polytron 3500

### Preparing for installation

The performance and effectiveness of the entire system depends essentially on the position chosen for installing the transmitter.

The following should be noted during installation:

- Local requirements and regulations governing the installation of gas measuring systems.
- Relevant regulations concerning the connection and routing of electric power supply and signal lines.
- The full scope of environmental factors to which the Polytron 3500 may be exposed (ambient conditions: see Technical Data, page 22).
- The specific uses (e.g. possible leaks).
- All other factors and conditions which could have a negative effect on the installation and operation of the system.
- Physical properties of the gas to be measured:
  - For gases with a density lower than that of air, the gas intake must be located above any possible leak or at the highest point at which large concentrations of gas may occur.
  - For gases and vapours with a density greater than that of air, the gas intake must be located below a possible leak or at the lowest point at which such gases and vapours may occur.
  - The humidity of the gas to be measured must be between 20 and 90 % relative humidity.
- Accessibility for the necessary maintenance work . see “Installing the Pyrolyzer docking station” on page 6.

Dräger Polytron 3500 consists of two main components:

- Pyrolyzer docking station.
- Dräger Polytron 3500.

## Installing the Pyrolyzer docking station

- Install in an area with low vibrations and stable temperatures.
  - Do not install in an area where there are draughts of very warm air (>40 °C).
- 1 During installation, the slots for fitting the Polytron 3500 must point upwards on the upper edge.
    - A space of at least 5 cm – preferably 10 cm – must be maintained above and to all sides for the installation of the Polytron 3500.
    - A space of at least 10 cm – preferably 30 cm - must be maintained below the docking station to permit access for maintenance.
  - 2 Push lock for connecting terminal block upwards, pull out 4-pin connecting terminal block from the front and insert it again after completion of the installation work.
    - Install the docking station using four screws e.g. M6 to a firm wall (drilling template: see page 27)

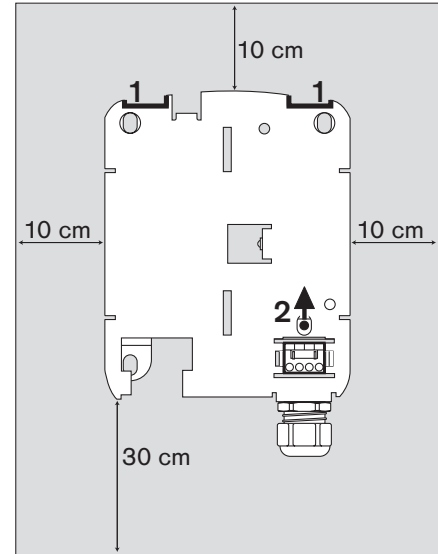

### Attention:

If the wall is not flat, use suitable spacers (such as mounting bracket 68 09 772) to prevent warping of the case.

## Electrical connections

### Caution:

Do not connect the unit to the mains before the electrical installation is complete and has been checked.

Connect the docking station to the central unit with a cable with at least three wires conductor cross-section, 0.5 to 2.5 mm<sup>2</sup>.

Line lengths: see "Maximum line lengths" on page 7.

- For currents of 0 and 22 mA, a DC voltage between 12 V DC and 26 V DC must be present at the unit (terminal +24 V and 4..20).

### 3-wire connection

#### – Installing the 4 to 20 mA current loop

- Install the 3-wire connection cable in the cable gland, cut it to length and strip off the insulation (about 80 mm).
- Shorten the shield (if installed) to prevent short-circuiting.
- Connecting the cable:
  - secure in terminals of 4-pin connecting terminal block – **ensure correct polarity.**
- 3 Slide connecting terminal block back into holder until the lock clicks into place.

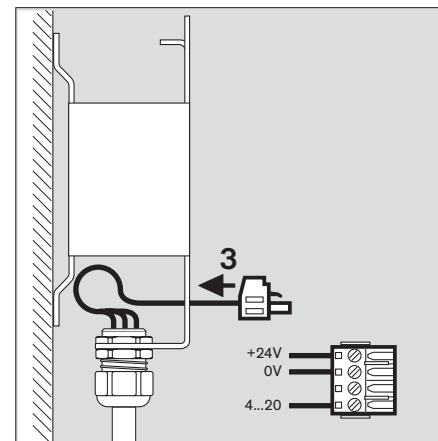

– Connecting to the central unit with a central power supply:

- Connect shield to GND of central unit (e.g. housing, earth bar, etc.).

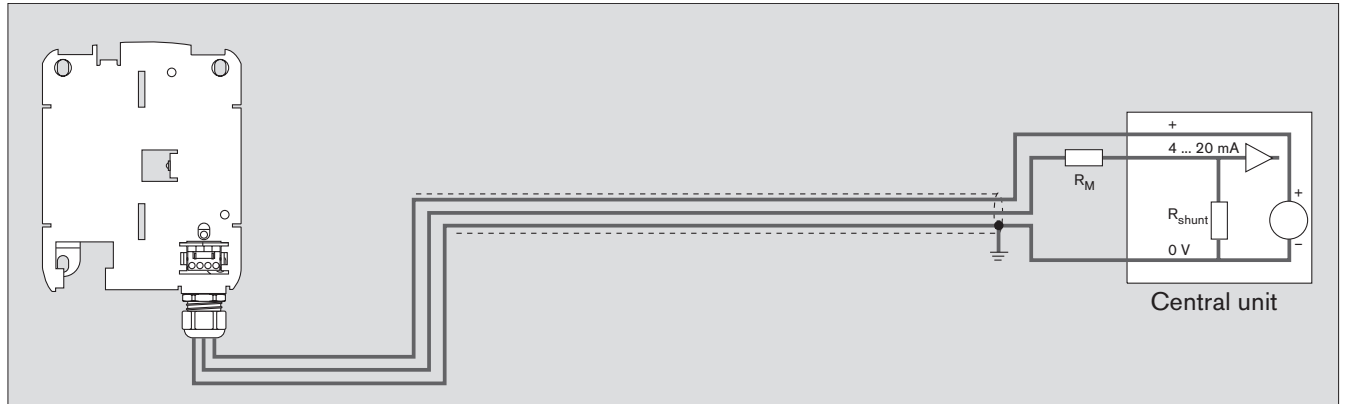

**Maximum line lengths**

Installing a remote central unit with power supply by 3-wire connection the voltage drop due to the line resistance [ $R_{line}$ ] has to be taken in consideration.

In order to detect a Pyrolyzer failure in the central unit [ $I_F$ ] and the current drawn by the Pyrolyzer in a fault situation (250 mA) combined with the cable cross-section [ $A$ ] and the shunt resistor [ $R_{shunt}$ ] will result in a maximum cable length [ $L_{max}$ ].

$$R_{line} = (R_{shunt} \times I_F) / 250 \text{ mA}$$

$$L_{max} = R_{line} \times A / (0.0175 \text{ Ohm} \times \text{mm}^2 / \text{m})$$

Example:

The following is valid with a permitted error current [ $I_F$ ] of 3.15 mA:

@ $R_{shunt} = 50 \text{ Ohm}$		@ $R_{shunt} = 100 \text{ Ohm}$		@ $R_{shunt} = 250 \text{ Ohm}$	
A	$L_{max}$	A	$L_{max}$	A	$L_{max}$
0.50 mm <sup>2</sup>	≥18.23 m	0.50 mm <sup>2</sup>	≥36.46 m	0.50 mm <sup>2</sup>	≥91.15 m
0.75 mm <sup>2</sup>	≥27.34 m	0.75 mm <sup>2</sup>	≥54.69 m	0.75 mm <sup>2</sup>	≥136.70 m
1.50 mm <sup>2</sup>	≥54.69 m	1.50 mm <sup>2</sup>	≥109.38 m	1.50 mm <sup>2</sup>	≥273.45 m
2.50 mm <sup>2</sup>	≥91.15 m	2.50 mm <sup>2</sup>	≥182.30 m	2.50 mm <sup>2</sup>	≥455.75 m

In a given situation the cable length [ $L_{max}$ ] can be increased by a series connection of a resistor [ $R_M$ ] into the cable for the 4 to 20 mA signal.

$$R_{schunt \text{ new}} = R_{shunt \text{ old}} + R_M$$

Following limitations have to be fulfilled:

$$R_{line} + R_{shunt} = \text{between } 30 \text{ Ohm and } 500 \text{ Ohm,}$$

For currents of 0 and 22 mA, a DC voltage between 12 V DC and 26 V DC must be present at the unit (terminal +24 V and 4..20), see page 6.

– Connecting to the central unit with individual power supplies:

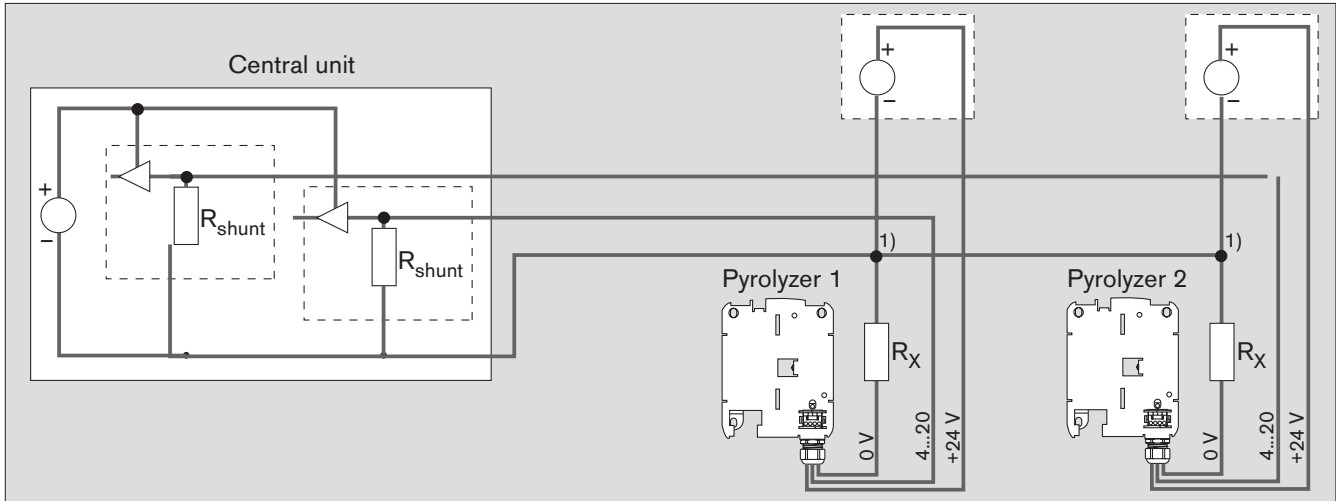

1) IMPORTANT: star-shaped ground system (no ground loops).

$R_x$  corresponds to the line resistance  $R_{line}$  from page 7.

04023927\_1\_de.eps



## Installing the Dräger Polytron 3500

- Unpack the Dräger Polytron 3500.
- Remove the cover of the Polytron 3500. To do this
  - 1 gently pull apart the cover on both sides and
  - 2 lift upwards.

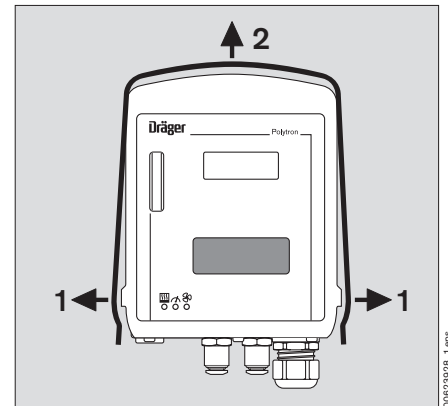

- Fit the Polytron 3500 using the metal hooks into the slots provided on the docking station.

**Attention! The electrical connection via the edge connector must be clean, i.e. the safety hooks (3) underneath must snap into the docking station.**

- Slide cover back over the installed station until it snaps into place at the sides.

**Attention! No cables or internal hoses must be pinched.**

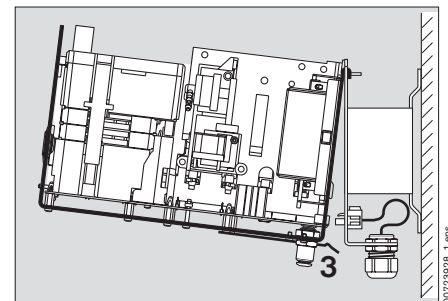

- Connecting the hoses: insert the hose into the quick release fastener below the unit as far as it will go (increased resistance).
- 4 Gas input from the inlet point right connection (marked with O-ring).
- 5 Gas output to the offtake left connection.
- Check the hoses to make sure they are inserted properly

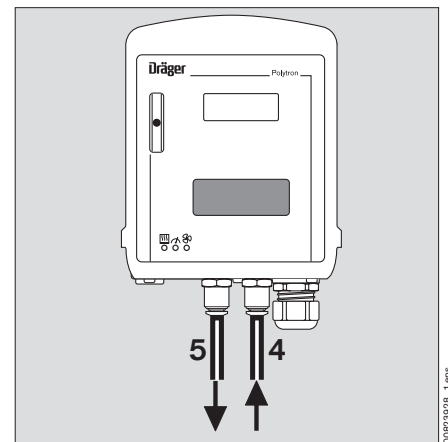

## Defining the calibration setting

If the manufacturer's calibration setting for the sensor is to be used:

- Open the cover of the service port. The maintenance switches and potentiometers for calibration are now revealed.
- 1 Jumper J1 must be set over the two left-hand pins or removed completely.

If the Polytron 3500 is specifically to be calibrated with calibration gas:

- Open the cover of the service port. The maintenance switches and potentiometers for calibration are now revealed.
- 2 Jumper J1 must be set over the two right-hand pins.

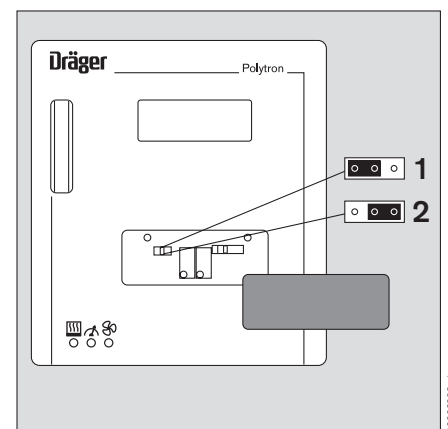

## Starting up the Polytron 3500

- Switch on power supply.
- The balls in the flow tube should be floating at half way.
  
- Polytron 3500 begins its warm-up routine. This is indicated by a flashing display. The warm-up phase takes between 5 minutes and 30 minutes depending on the sensor installed. See the related information in the operating instructions for the DrägerSensor. The warm-up phase may take longer in extremely high or low temperatures. It is completed when the display stops flashing.

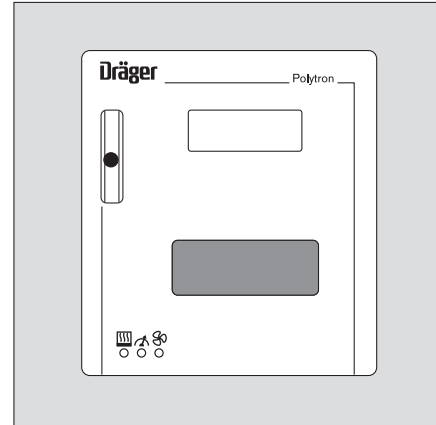

### When the sensor has warmed up:

Units set for specific calibration with calibration gas:

- Calibrate sensor, page 13.
- Check signal transmission to the central unit and alarm output.

Transmitters set for use of the manufacturer's calibration setting for the sensor:

- The Polytron 3500 is ready for use.
- Check signal transmission to the central unit and alarm output.

## Analogue signal

- A current between 4 and 20 mA flows through the current loop during normal operation. This current is proportional to the gas concentration.
- The Polytron 3500 uses various current values to indicate the operating status of the unit:

Current	Meaning
4 mA	Zero point
20 mA	Full-scale value
<3.2 mA; 21 mA	Fault
3.8 mA to 4 mA	Sensor drift below zero point
20 mA to 20.5 mA	Measuring range exceeded
3.4 mA $\pm$ 0.2 mA, constant	Maintenance signal

## Display

- In measuring mode, the display shows the actual gas concentration, e.g.:

The following symbols may be displayed during measurement:

- If a fault has been detected:
- If the measuring range has been exceeded:
- If the measuring range is too low (sensor drift below the zero point):



01123928\_1.epa



0123928\_1.epa





01323928\_1.epa



01423928\_1.epa

## Displays of control LEDs

- LED »  « – pyrolysis oven  
lights green when there is no error  
lights red when the pyrolysis oven is defect. Replace the pyrolysis oven, page 19.
- LED »  « – pump measurement branch  
lights green when there is no error  
lights red when the flow rate in the measurement branch is not sufficient. Replace the pump, page 18.  
flashes red when an internal flow test is carried out.
- LED »  « – pump – principal branch  
lights green when there is no error  
lights red when the flow rate in the principal branch is not sufficient. Replace the pump, page 18.

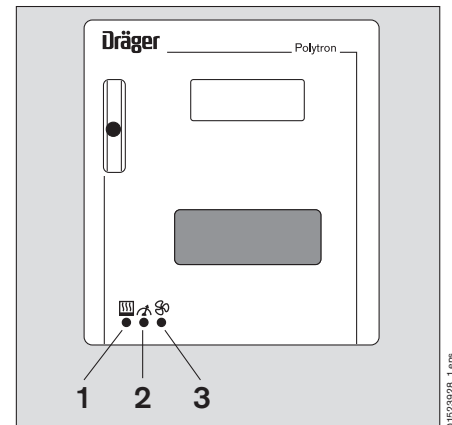

01523928\_1.epa

## Maintenance

### Maintenance intervals

#### Before starting operation:

- Check the calibration, see page 13.
- Check signal transmission to the central unit and alarm output.

#### At regular intervals to be defined by the person responsible for the gas warning installation:

- Check signal transmission to the central unit and alarm output.

If a selective filter specific to the sensor is being used:

- Replace the selective filter –  
See the related Instructions for Use for details of the capacity of the selective filter being used.
- Calibrate the sensor, see page 13.  
The interval for regular calibration depends on the sensor being used and on the operating conditions.  
Specific calibration data for the sensor, see the Instructions for Use for the Dräger sensor.

#### At the latest every twelve months:

- Inspection by specialists.  
The inspection intervals must be established in each individual case and shortened if necessary, depending on technical safety considerations, engineering conditions and the technical requirements of the equipment.  
We recommend that a service contract be obtained with Dräger Safety and that all repairs also be carried out by them.
- In order to check for leaks, measure the flow at the inlet point and behind the Polytron 3500.

#### As required:

- Replace the sensor, page 16.
- Replace the pump, page 18.
- Replace the pyrolysis oven, page 19.
- Replace the internal dust filter, page 20.

## Calibrating the unit

- Ensure that the sensor is warmed up before it is calibrated. Warming-up time: see the Instructions for Use for the DrägerSensor.
- The Polytron 3500 can be calibrated by the operator on site.
- **For critical applications**, the calibration intervals are to be defined in accordance with the recommendations in EN 50073<sup>1)</sup> or EN45544-4<sup>2)</sup> and national regulations.

### Note the calibration sequence!

- First check the zero point and correct it necessary, Immediately after this, check the sensitivity and adjust it as necessary.
- Never calibrate the sensitivity before calibrating the zero point.
- Zero gas and calibration gas: See the related information in the Instructions for Use for the DrägerSensor.

#### Caution:

#### Calibration gas must not be inhaled. Risk to health!

Care must be taken about the risks which can arise when using test gas; hazard instructions and safety advice must be observed.

For details, see appropriate Safety Sheets.

- Open the cover of the service port. The maintenance switch and potentiometers for calibration are now revealed.

#### Note:

**Calibration data are not transmitted to the sensor during this calibration process!**

### Measuring / maintenance mode

- 1 Maintenance switch with two positions.
- 2 Measuring mode position (left-hand position) – measured values are relayed to the analogue output.
- 3 Maintenance mode position (right-hand position) – a maintenance signal (3.4 mA  $\pm$ 0.2 mA constant) is relayed to the analogue output and prevents alarms being triggered.

1) EN 50073 – Guidelines for selection, installation, use and maintenance of devices for the detection and measurement of flammable gases and oxygen.

2) EN 45544-4 – Electrical devices for the direct detection and direct concentration measurement of toxic gases and vapours – Part 4: Guidelines for selection, installation, use and maintenance.

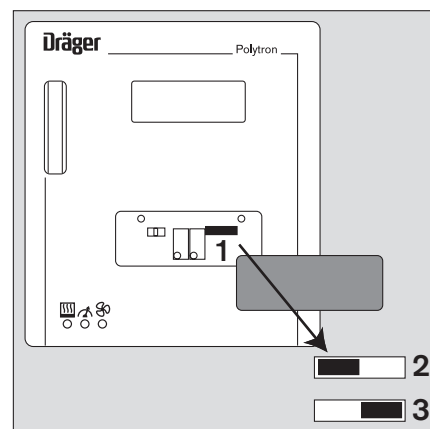
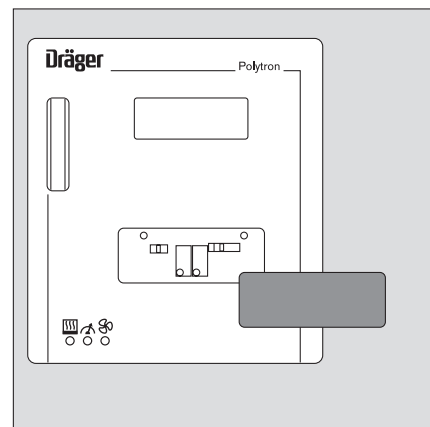

### Jumper

- 4 Jumper J1 can be set to two positions.
- 5 The left-hand position or complete removal of jumper J1 in order to use the manufacturer's calibration setting for the sensor.
- 6 The right-hand position for calibration with calibration gas and the potentiometers for zero point and sensitivity.
- Only the manufacturer's calibration setting for the sensor can be used when jumper J1 has been placed or is missing over the two left-hand pins.
  - Calibration with calibration gas can be performed when jumper J1 has been set over the two right-hand pins.

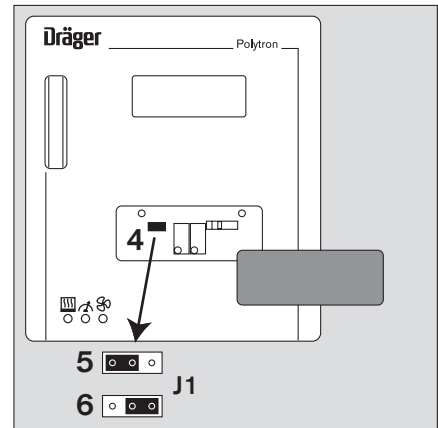

### Operating elements

- 7 Potentiometer (left) for calibration of the zero point.
- 8 Potentiometer (right) for calibration of the sensitivity.

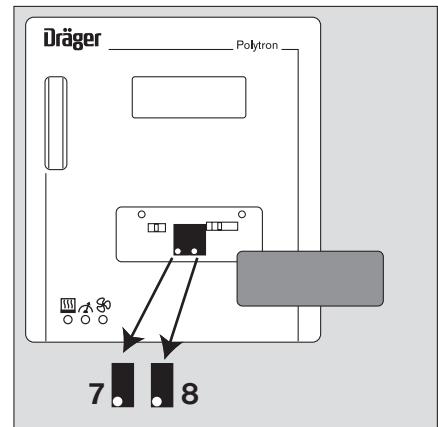

### Calibrating the zero point

The zero point can be calibrated without the use of zero gas when the ambient air is free from measuring gas and other interfering gases. Alternatively

- Set maintenance switch to maintenance position, see page 13.
- Remove the inlet line on the Polytron 3500.
- Provide zero gas with a flow rate of 1.5 L/min via a T-piece to the inlet connection. Connect a hose with a length of 0.5 m and a diameter which is larger than the hose for the Polytron 3500 to the third connection of the T-piece.

**Attention! Never release zero gas directly (without T-piece) from a compressed air cylinder!**

- Wait for the measured value to stabilise – approx. 3 minutes. See the related information in the operating instructions for the DrägerSensor.
- 7 Set the potentiometer for the zero point so that the display shows 0.
- Switch off zero gas and reconnect the inlet line.
  - Set maintenance switch to measuring position, see page 13.

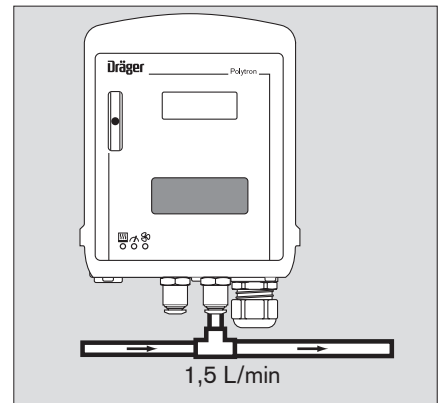

### Calibrating the sensitivity

**Caution:**

**Test gas must not be inhaled. Risk to health!**  
**Care must be taken about the risks which can arise when using test gas; hazard instructions and safety advice must be observed.**  
**For details, see appropriate Safety Sheets.**

- The recommended calibration gas concentration for optimum accuracy is between 40 % and 100 % of the measuring range end value.

- 1 Remove the inlet line on the Polytron 3500.
  - Set maintenance switch to maintenance position, see page 13.
  - 2 Fill gas bag (Order No. 68 07 068) with the calibration gas and connect to the inlet connection of the Polytron 3500.
- Wait for the measured value to stabilise – approx. 3 minutes. See the related information in the operating instructions for the DrägerSensor.

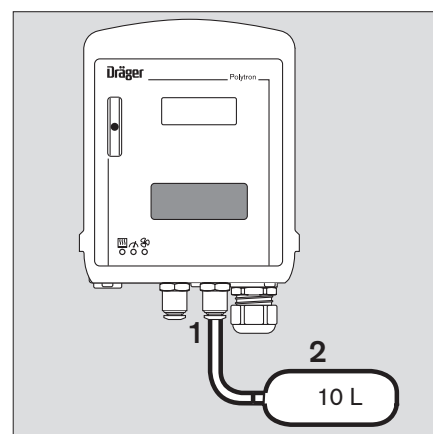

- 3 Set the potentiometer for sensitivity so that the display shows the concentration of the calibration gas.
  - Switch off calibration gas and reconnect inlet line.
  - Wait until the measured value drops below the alarm threshold set on the central unit, otherwise an alarm will be triggered when the maintenance switch is returned to the measuring position immediately after calibration.
- 4 **Set maintenance switch to measuring position, see page 13.**  
**The 4 to 20 mA output changes to measuring mode.**
  - Refit the cover for the service port.

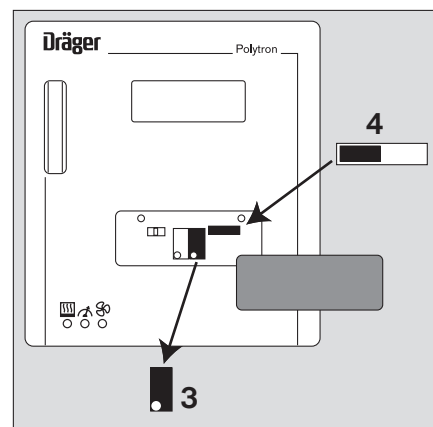

## Replacing the sensor

The sensor can be replaced, if necessary, without interrupting the supply voltage. Use only DrägerSensors, which are approved for use with the Polytron 3500.

Type	Order No.	
	Polytron 3500	DrägerSensor
Dräger Polytron 3500 0 to 50 ppm $\text{NF}_3$ (CAS 7783-54-2)	83 18 824	68 11 125
Dräger Polytron 3500 0 to 30 ppm $\text{C}_5\text{F}_8$ (CAS 559-40-0)	83 18 825	68 11 120
Dräger Polytron 3500 0 to 30 ppm $\text{C}_4\text{F}_6$ (CAS 685-63-2)	83 18 826	68 11 120

- Open the cover of the service port. The maintenance switch and potentiometers for calibration are now revealed.
- 1 Set maintenance switch to right-hand position. The 4 to 20 mA output changes to maintenance mode. In this position, a maintenance signal is relayed to the analogue output and prevents alarms being triggered.

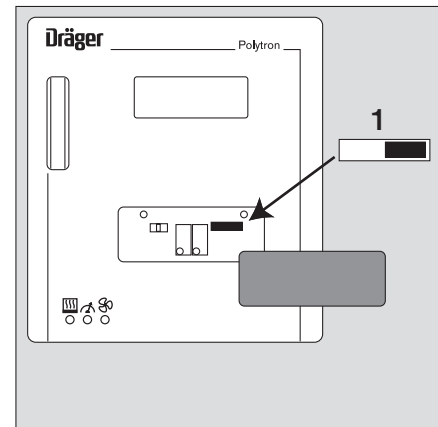

- Remove the cover of the Polytron 3500, by gently pulling apart the cover on both sides and lifting upwards.

**Attention!**

**When the unit is opened, there is the danger of scalding yourself on hot parts of the Polytron 3500.**

- 2 Loosen the sensor adapter from the sensor.
  - 3 Remove the sensor from the socket on the printed circuit board.
- Remove the new sensor from the packaging. Check that the sensor type is identical to the one which is installed in the Polytron 3500.  
**Remove the protective cap from the sensor on the DrägerSensor XS PFC!**
  - There is a keyed connector on the back of the sensor. Insert the sensor such into the socket on the printed circuit board so that the key of the connector matches the key of the socket.  
Incorrect connection can damage the sensor!
  - 2 Fit sensor adapter onto the sensor.
  - Refit the cover of the Polytron 3500.
  - Wait until the measured value drops below the alarm threshold set on the central unit, otherwise an alarm will be triggered when the maintenance switch is returned to the measuring position immediately after the sensor replacement.

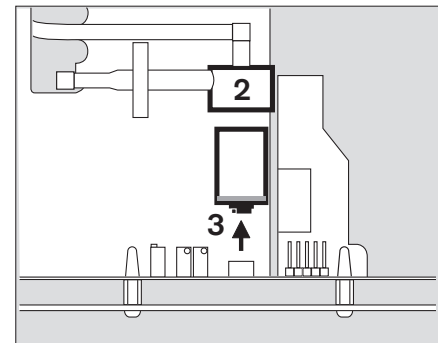



- 1 Set maintenance switch to left-hand position.  
The 4 to 20 mA output changes to measuring mode.
- Refit the cover for the service port.

#### When the sensor has warmed up:

- Units set for a transmitter-specific calibration with calibration gas:
- Calibrate sensor, page 13.
- Units set for use of the manufacturer's calibration setting for the sensor:
- The Polytron 3500 is ready for use again.

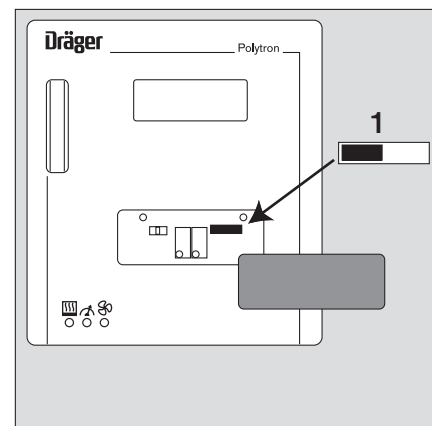

#### Disposal of electrochemical sensors:

- Sensors must be disposed of as special waste.

#### Caution:

- Do not throw sensors into the fire – explosion hazard.
- Do not open sensors forcibly – risk of caustic burns.

Note the relevant waste disposal regulations.

Further information can be obtained from the relevant local authority and from appropriate waste disposal companies.

## Replacing the pump

- Disable the supply voltage.
- Remove the cover of the Polytron 3500. To do this
  - 1 gently pull apart the cover on both sides and
  - 2 lift upwards.

### Attention!

When the unit is opened, there is the danger of scalding yourself on hot parts of the Polytron 3500.

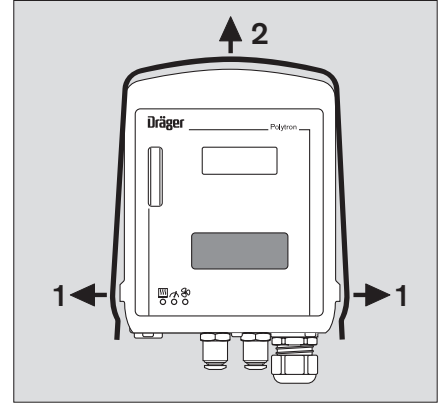

## Replace the pump for the measurement branch

- Pump on the right side in front of the pyrolysis oven.

- Remove the connector of the pump.
  - Remove the upper holder of the pump from the middle sheet.
  - Remove the hose from the pump and insert it into the new pump at the same position.
  - Refit the new pump (without blue sticker) sideways on the lower holder.
  - Insert the upper holder of the pump into the middle sheet and pull through.
  - Insert the connector of the new pump into the socket on the printed circuit board.
- Ensure correct polarity! Blue cable to the outside.**

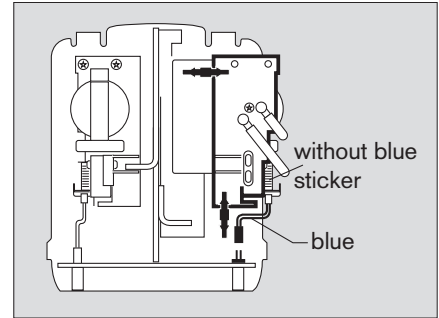

## Replace the pump for the principal branch

- Pump on the left side in front of the rear wall.

- Remove the connector of the pump.
  - Remove the upper holder of the pump from the middle sheet.
  - Remove the hose from the pump and insert it into the new pump at the same position.
  - Refit the new pump (with blue sticker sideways on the lower holder.
  - Insert the upper holder of the pump into the middle sheet and pull through.
  - Insert the connector of the new pump into the socket on the printed circuit board.
- Ensure correct polarity! Blue cable to the outside.**

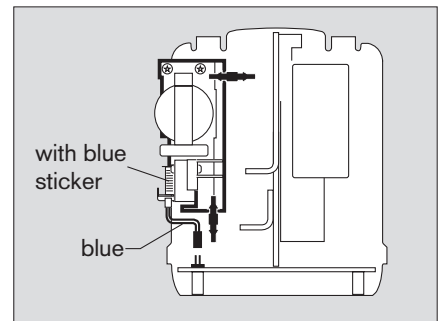

- Refit the cover of the Polytron 3500.
- Switch on power supply.
- Wait until the sensor has fully warmed up.
- The Polytron 3500 is ready for use again.

## Replacing the pyrolysis oven

- Disable the supply voltage.
- Remove the cover of the Polytron 3500. To do this
  - 1 gently pull apart the cover on both sides and
  - 2 lift upwards.

### Attention!

When the unit is opened, there is the danger of scalding yourself on hot parts of the Polytron 3500.

Only use a pyrolysis oven, which is suitable for use with the Polytron 3500 with the defined gas type, see “Order List” auf Seite 23.

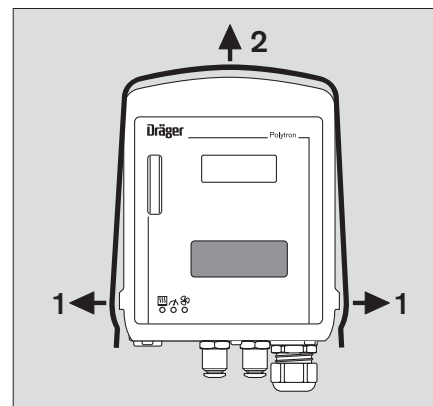

- Disconnect the three electrical connections of the pyrolysis oven on the printed circuit board.
- Loosen the two screws for fixing on the rear side – do not unscrew completely.
- Remove the pyrolysis oven upwards from the holder.
  
- Remove the hoses to the pyrolysis oven and connect to the new pyrolysis oven at the same position.
- Insert the new pyrolysis oven from above into the holder and tighten the two screws.
- Reconnect the three electrical connections of the pyrolysis oven.

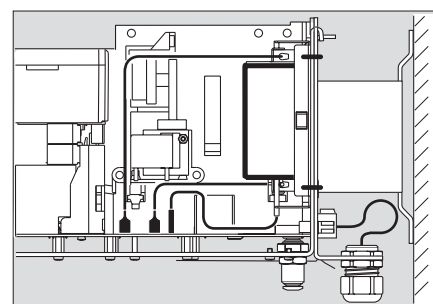

- Refit the cover of the Polytron 3500.
- Switch on power supply.
- Wait until the sensor has fully warmed up.
- The Polytron 3500 is ready for use again.

## Replacing the internal dust filter

- The internal dust filter can be replaced without interrupting the supply voltage.

**Attention!**

The measurement result that is displayed during the replacement is not correct.

- Remove the cover of the Polytron 3500. To do this

- 1 gently pull apart the cover on both sides and
- 2 lift upwards.

**Attention!**

When the unit is opened, there is the danger of scalding yourself on hot parts of the Polytron 3500.

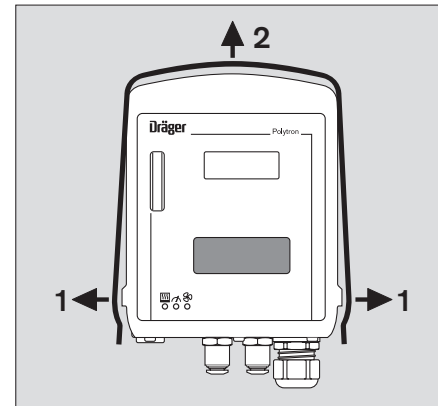





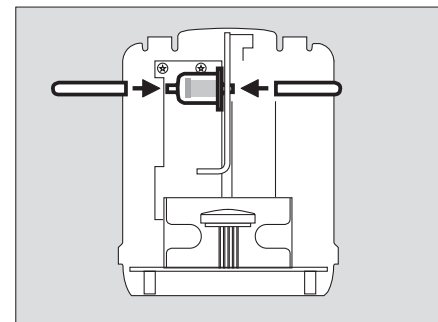





- Disconnect hose connections from the dust filter and connect to the new dust filter at the same position.

- Refit the cover of the Polytron 3500.
  - The Polytron 3500 is ready for use again.



## Fault – Cause – Remedy

Fault	Cause	Remedy
Flashing display	Sensor is warming up	Wait for warm-up phase to end.
Display  9323928_1.rps	Equipment fault, e.g. wrong sensor installed	Only use a sensor which is suitable for use with the type of Polytron 3500 being used, page 16.
Display  9323928_1.rps	Measuring range end value exceeded	Wait until the gas concentration is within the measuring range.
Display  9323928_1.rps	Value too far below zero point	If this occurs often: calibrate the zero point, page 14.
LED »  « lights red	The pyrolysis oven is defect	Replace the pyrolysis oven , page 19.
LED »  « lights red	Fault in measurement branch – pump measurement branch defect	Check the hose connections for blockages. Replace the pump, page 18.
LED »  « flashes red	An internal flow test is being carried out – this is not a fault	– – –
LED »  « lights red	Fault in principal branch – pump principal branch defect	Check the hose connections for blockages. Replace the pump, page 18.
All three LEDs »  «, »  « and »  « lights or flashes red	Electronic defect	Polytron 3500 to be repaired by Service of Dräger Safety.

## Technical Data

The measuring range and the measuring properties depend on the DrägerSensor – see the Instructions for Use of the DrägerSensor being used.

Type	Microprocessor controlled transmitter with pump and pyrolysis oven
Measuring range and measuring properties	depend on the type – see the Instructions for Use of the installed DrägerSensor
Flow rate	900 ±100 mL/min; Hose inside diameter 4 mm, hose outside diameter 6 mm
Signal transmission to the central unit	
Measured-value signal	4 mA to 20 mA
Drift below zero point	3.8 mA
Measuring range exceeded	20 mA to 20.5 mA
Unit fault	<3.2 mA or >21 mA
Maintenance signal	3.4 mA ±0.2 mA constant
Supply voltage	24 V DC ±2 V; 1.5 A
Cable inlet	M20x1.5, for cable diameter 6 to 12 mm (0.24" to 0.47")
Ambient conditions	Specifications for the sensor: see the Instructions for Use for the DrägerSensor 0 to 40 °C 700 to 1300 hPa 0 to 99 % relative humidity, no condensation
Dimensions (H x W x D)	150 mm x 125 mm x 300 mm
Weight	approx. 2.4 kg
CE markings	Electromagnetic compatibility (Directive 89/336/EEC)
Ingress protection	IP 21

## Order List

Part name and description	Order No.
<b>Pyrolyzer Docking Station</b> Once per Dräger Polytron 3500	<b>83 18 580</b>
<b>Dräger Polytron 3500 – NF<sub>3</sub></b> Measuring range 0 to 50 ppm NF <sub>3</sub> (CAS 7783-54-2)	<b>83 18 824</b>
<b>Dräger Polytron 3500 – C<sub>5</sub>F<sub>8</sub></b> Measuring range 0 to 30 ppm C <sub>5</sub> F <sub>8</sub> (CAS 559-40-0)	<b>83 18 825</b>
<b>Dräger Polytron 3500 – C<sub>4</sub>F<sub>6</sub></b> Measuring range 0 to 30 ppm C <sub>4</sub> F <sub>6</sub> (CAS 685-63-2)	<b>83 18 826</b>
<b>Calibration accessories</b>	
<b>Calibration Bag, 10 L</b>	<b>68 07 068</b>
<b>Spare parts</b>	
<b>DrägerSensor XS NF3</b> for Dräger Polytron 3500 – 83 18 824	<b>68 11 125</b>
<b>DrägerSensor XS PFC</b> for Dräger Polytron 3500 – 83 18 825 and 83 18 826	<b>68 11 120</b>
<b>Pyrolysis oven NF3</b>	<b>83 18 340</b>
<b>Pyrolysis oven PFC</b>	<b>83 18 820</b>
<b>Spare part set pump (83 18 523)</b> for the measurement branch	<b>83 19 518</b>
<b>Spare part set pump (83 18 996)</b> for the principal branch	<b>83 19 519</b>
<b>Dust Filter</b> internal	<b>83 17 348</b>
<b>Cover</b> , unit cover	<b>83 18 528</b>
<b>Cap</b> , for maintenance port	<b>83 18 516</b>

## Index

3-wire technology .....	6
Accessibility for the maintenance work .....	5
Accessories .....	3
Ambient conditions .....	22
Analogue signal .....	10
Areas subject to explosion hazards .....	3
Calibrating the sensitivity .....	15
Calibrating the zero point .....	14
Calibration .....	12
Calibration accessories .....	23
Calibration gas .....	13
Calibration interval .....	13
CE markings .....	22
Connecting to the central unit .....	6, 7, 8
Control LEDs .....	11
Defining the calibration setting .....	9
Density of the gas .....	5
Dimensions .....	22
Display .....	11
Displays of control LEDs .....	11
Disposal of electrochemical sensors .....	17
Drilling templates .....	27
Electrical connections .....	6
Environmental factors .....	5
Fault .....	10, 21
Flow rate .....	22
Full-scale value .....	10
Ingress protection .....	22
Inspection .....	12
Installation location .....	5, 6
Installing .....	5
Installing the 4 to 20 mA current loop .....	6
Installing the docking station .....	6
Installing the Polytron 3500 .....	9
Intended Use .....	4
Liability .....	3
Line lengths .....	7
Line resistance .....	7



Maintenance .....	3, 12
Maintenance intervals .....	12
Maintenance mode .....	13
Maintenance signal .....	10
Maximum line lengths .....	7
Measuring mode .....	13
Measuring properties .....	22
Measuring range .....	22
Measuring range exceeded .....	10
Order List .....	23
Potentiometer for calibration .....	14
Preparing for installation .....	5
Pump for the measurement branch .....	18
Pump for the principal branch .....	18
Replace the internal dust filter .....	12
Replace the pump .....	12
Replace the pyrolysis oven .....	12
Replace the sensor .....	12
Replacing the internal dust filter .....	20
Replacing the pump .....	18
Replacing the pyrolysis oven .....	19
Replacing the sensor .....	16
Safety .....	3
Sensor drift below zero point .....	10
Signal transmission to the central unit .....	12, 22
Spare parts .....	23
Start-up .....	10
Supply voltage .....	22
Technical Data .....	22
Unit calibration .....	13
Warm-up period of the sensor .....	17
Warm-up phase .....	10
Weight .....	22
Zero gas .....	13



## Drilling templates

### Pyrolyzer Docking Station

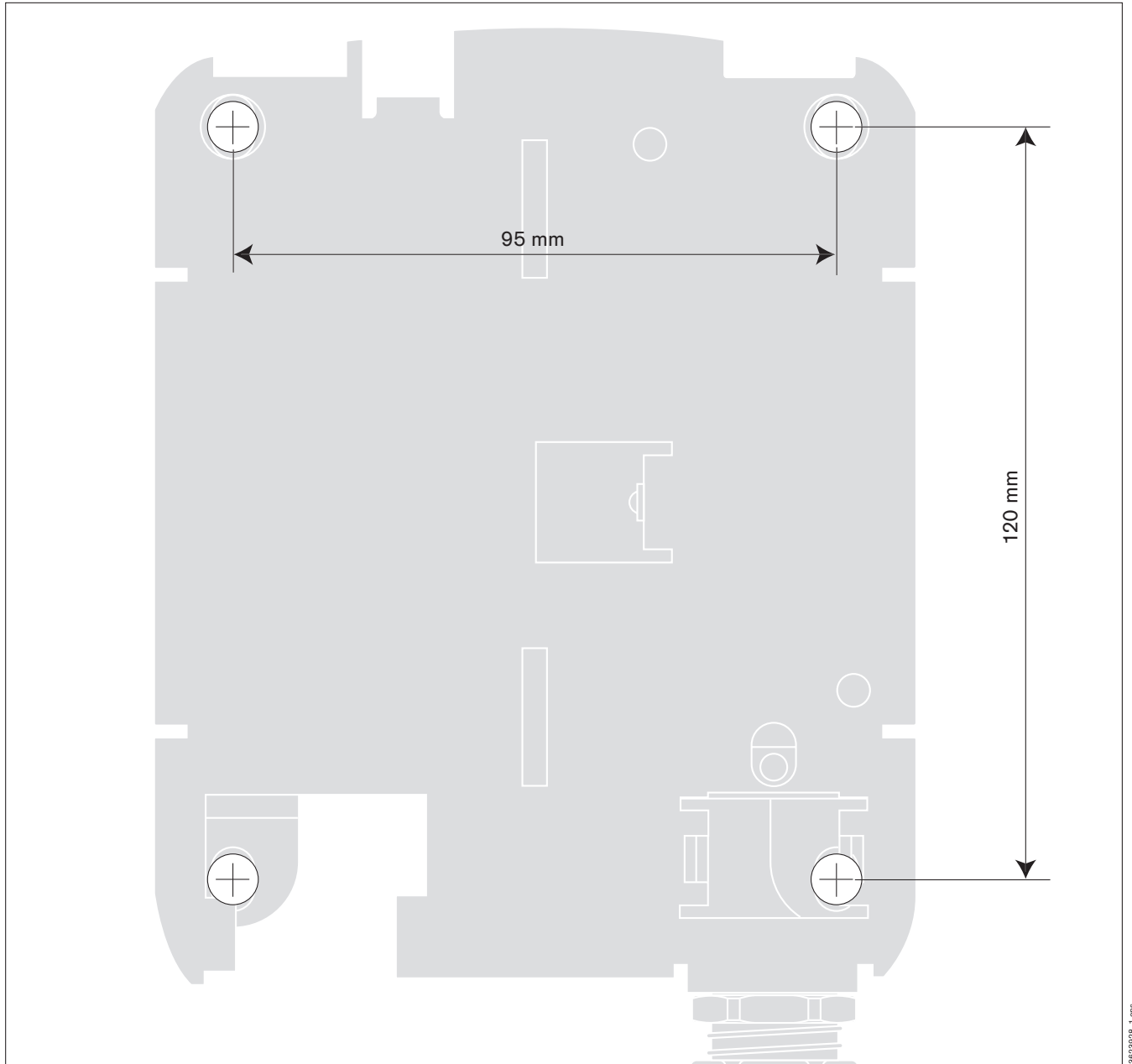

03023928\_1.dwg



Thank you for reading this data sheet.

For pricing or for further information, please contact us at our UK Office, using the details below.



**UK Office**

**Keison Products,**

**P.O. Box 2124, Chelmsford, Essex, CM1 3UP, England.**

**Tel: +44 (0)1245 600560**

**Fax: +44 (0)1245 808399**

**Email: [sales@keison.co.uk](mailto:sales@keison.co.uk)**

Please note - Product designs and specifications are subject to change without notice. The user is responsible for determining the suitability of this product.